

A close-up photograph of motocross goggles. The goggles have a white frame with orange and blue accents. The lens is purple and reflects a pink and orange gradient. A black strap with a blue 'RB' logo is attached. The 'Red Bull' logo is visible on the side of the frame. The text 'MARCUS PFEIL Custom painting' is on the blue part of the frame. The word 'GOGGLES' is overlaid in white text.

GOGGLES



PROSPECT

THE ULTIMATE GOGGLE TO OPTIMIZE CONTRAST AND CLARITY.

The SCOTT Prospect AMP Goggle not only defends, but also enhances your vision when riding. These lenses are injection molded to provide improved definition and optical clarity, allowing you to see contours and transitions in the dirt like never before.

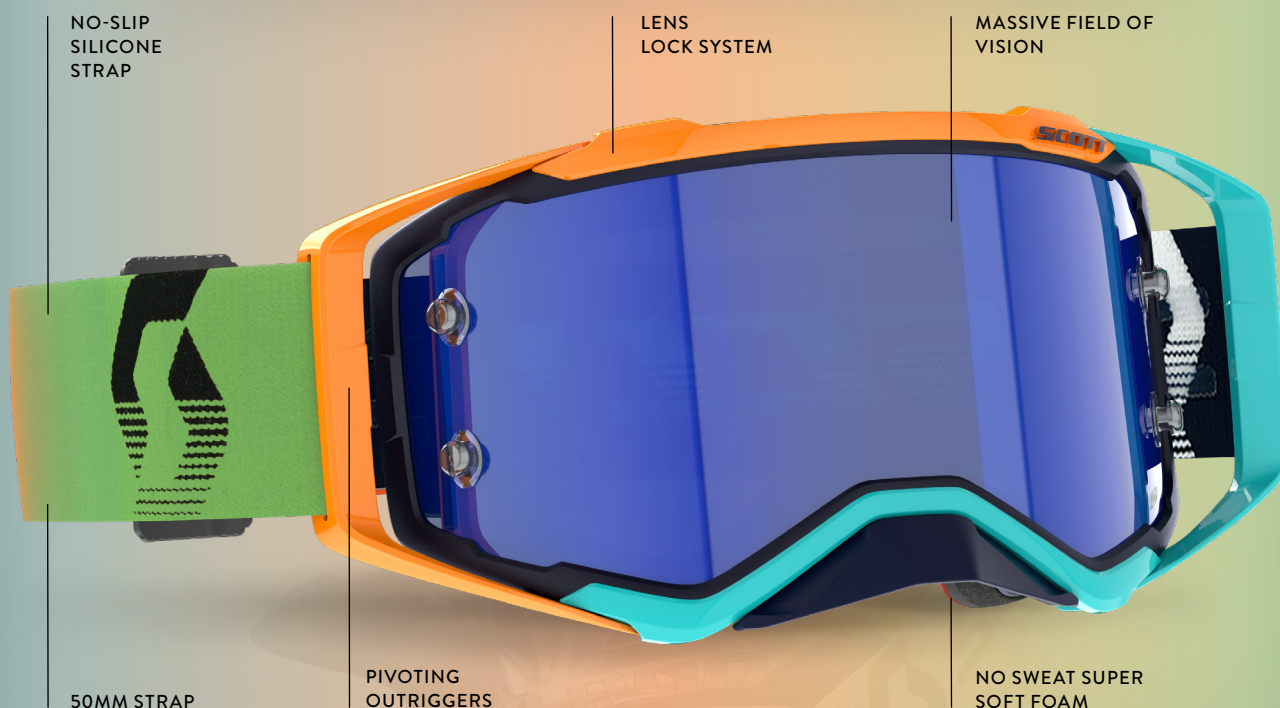

NO-SLIP SILICONE STRAP

LENS LOCK SYSTEM

MASSIVE FIELD OF VISION

50MM STRAP

PIVOTING OUTRIGGERS

NO SWEAT SUPER SOFT FOAM

AMP

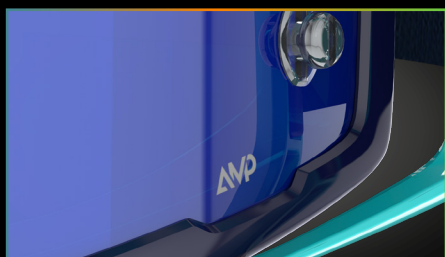

AMP TECHNOLOGY

The injected AMP lens increases clarity and contrast to offer riders superior vision over a standard lens.



LENS LOCK SYSTEM

With this feature SCOTT guarantees the safest lens retention on the market. It features 4 locking pins that go through the lens keeping the lens in no matter what.



PIVOTING OUTRIGGERS

The two pivoting outriggers adapt to any helmet shape, providing a good seal on the rider's face.



The SCOTT Prospect AMP Goggle not only defends, but also enhances your vision when riding. These lenses are injection molded to provide improved definition and optical clarity, allowing you to see contours and transitions in the dirt like never before. With other perfected features such as the NoSweat face foam, a maximum field of vision, the innovative SCOTT Lens Lock System, articulating outriggers and much more, the super-stylish SCOTT AMP Prospect Goggle has been engineered to Defend Your Vision no matter how extreme the conditions get.

FRAME TECHNOLOGIES

- Lens Lock System
- NoSweat 3-layer molded face foam
- Articulated outriggers
- Extra wide no-slip silicone strap

LENS TECHNOLOGIES

- 100% UV Protection
- Impact protection
- NoFog™ Anti-Fog lens treatment
- SCOTT AMP Lens Technology
- Single Lens Works

EXTRAS:

- Microfiber Goggle bag
- Noseguard

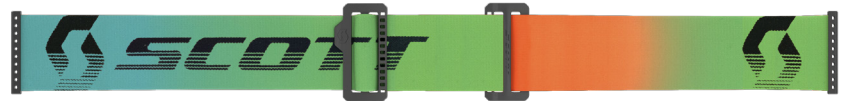
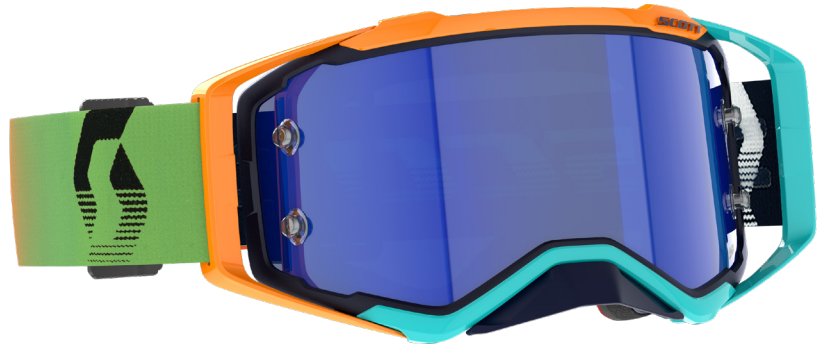

blue/orange | blue chrome works
1454349



goggle bag



noseguard



grey/orange | gold chrome works
1294324

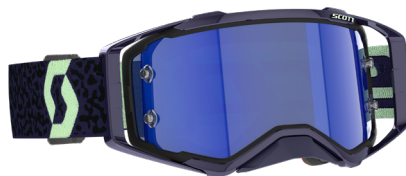

dark purple/mint green | blue chrome works
7696349



white/black | gold chrome works
1035324



grey/orange | rose works
1294352

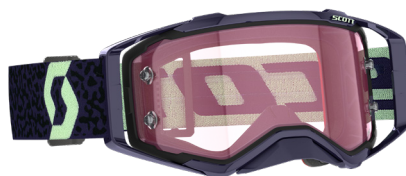

dark purple/mint green | rose works
7696352



white/black | rose works
1035352



blue/orange | rose works
1454352

PROSPECT

THE PINNACLE OF MOTO GOGGLE DESIGN AND INNOVATION.

The Prospect is the ultimate moto goggle. Designed from the ground up with performance in mind, this top-of-the-range goggle offers uncompromised vision, maximum protection and ultimate style.

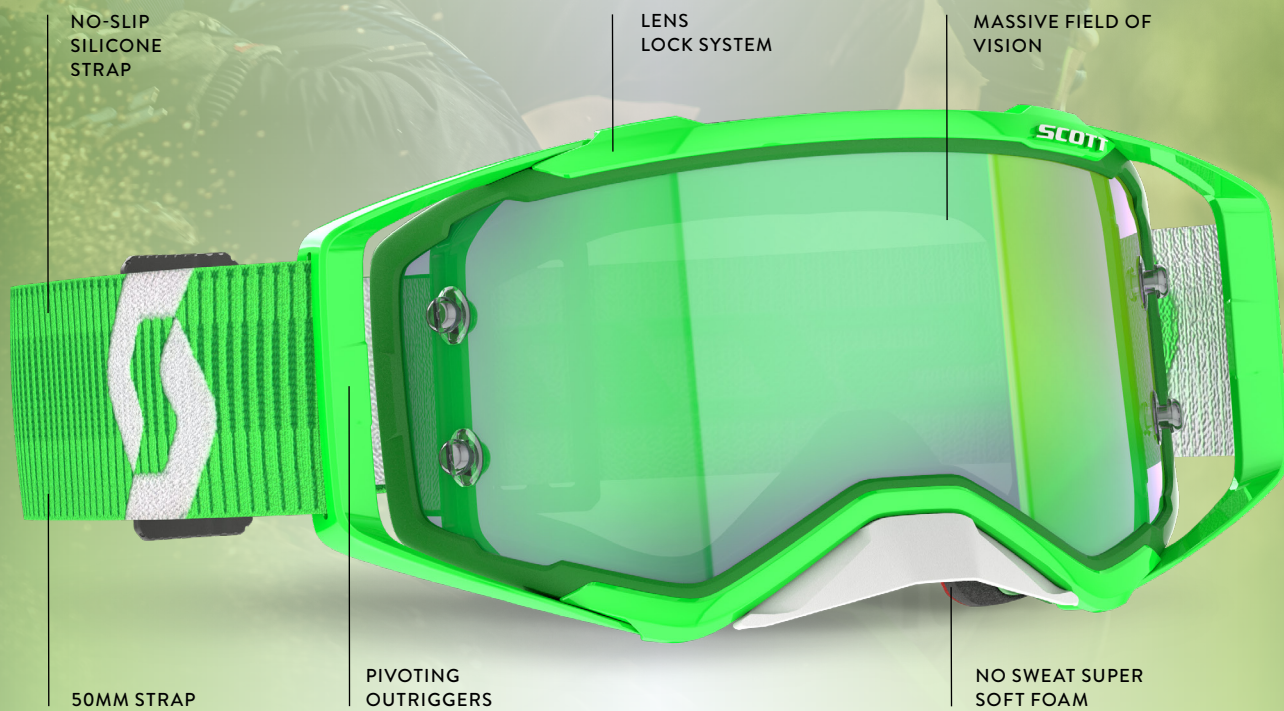

NO-SLIP SILICONE STRAP

LENS LOCK SYSTEM

MASSIVE FIELD OF VISION

50MM STRAP

PIVOTING OUTRIGGERS

NO SWEAT SUPER SOFT FOAM

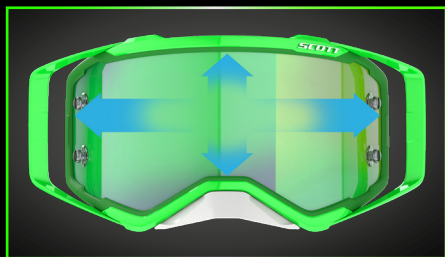

MASSIVE FIELD OF VISION

SCOTT offers the largest field of vision on the market. The larger lens and the thin frame construction bring the lens closer to your eyes maximizing your vision to the fullest.

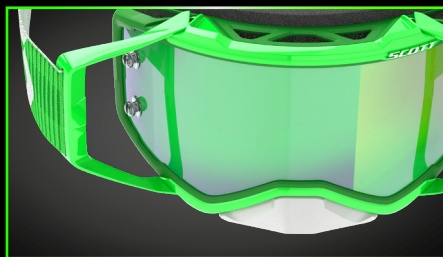

LENS LOCK SYSTEM

With this feature SCOTT guarantees the safest lens retention on the market. It features 4 locking pins that go through the lens keeping the lens in no matter what.

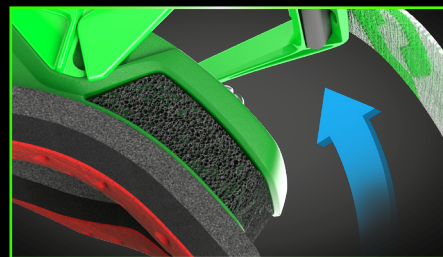

PIVOTING OUTRIGGERS

The two pivoting outriggers adapt to any helmet shape, providing a good seal on the rider's face.



The SCOTT Prospect is our flagship off-road motocross goggle. Used by an ever-growing list of champions, the Prospect goggle has everything you need to ensure your vision is the best it can be on the track or trail. With perfected features such as the NoSweat face foam, a maximum field of vision, the innovative SCOTT Lens Lock System, articulating outriggers and much more, the super-stylish SCOTT Prospect goggle has been engineered to Defend Your Vision no matter how extreme the conditions get.

FRAME TECHNOLOGIES

- Lens Lock System
- NoSweat 3-layer molded face foam
- Articulated outriggers
- Extra wide no-slip silicone strap

LENS TECHNOLOGIES

- 100% UV Protection
- NoFog™ Anti-Fog lens treatment
- Single Lens Works

EXTRAS:

- Bonus Clear lens included
- Microfiber Goggle bag
- Noseguard

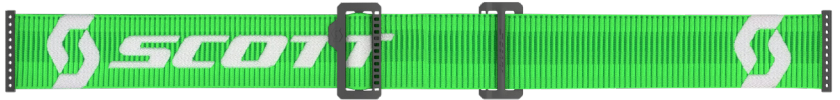
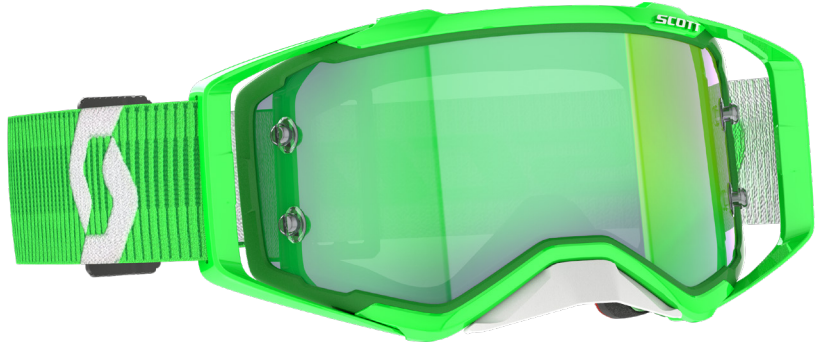

green/white | green chrome works
1075279



clear lens



goggle bag



noseguard



premium black/white | purple chrome works
7702281

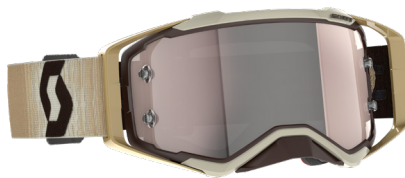

beige/brown | silver chrome works
1074269

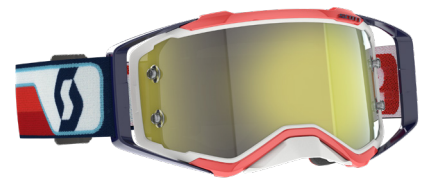

red/white | yellow chrome works
1005289



red/black | silver chrome works
1018269

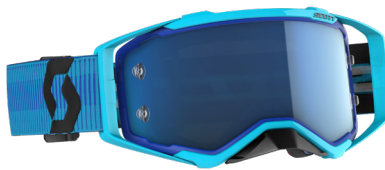

blue/black | blue chrome works
1034349



orange/yellow | orange chrome works
1649280

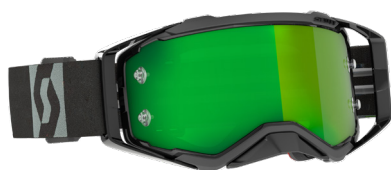

black/grey | green chrome works
1001279



The SCOTT Prospect Light Sensitive Goggle is an absolute highlight among off-road and motocross goggles. It gives the rider a maximum field of vision and features an innovative SCOTT Lens Lock System that makes the lens stay in the frame no matter what impact is coming from outside. Like the regular Prospect, this model comes with NoSweat face foam. What makes this goggle so special is the Light Sensitive lens, which adapts automatically to sunlight intensity. With this lens you are equipped for any and all light conditions!

FRAME TECHNOLOGIES

- Lens Lock System
- NoSweat 3-layer molded face foam
- Articulated outriggers
- Extra wide no-slip silicone strap

LENS TECHNOLOGIES

- 100% UV Protection
- NoFog™ Anti-Fog lens treatment
- SCOTT Light Sensitive photochromic lens technology
- Single Lens Works

EXTRAS:

- Microfiber Goggle bag
- Noseguard

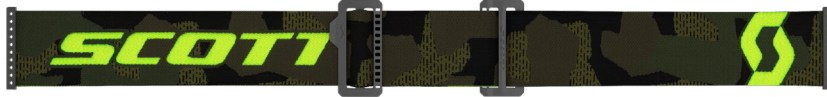
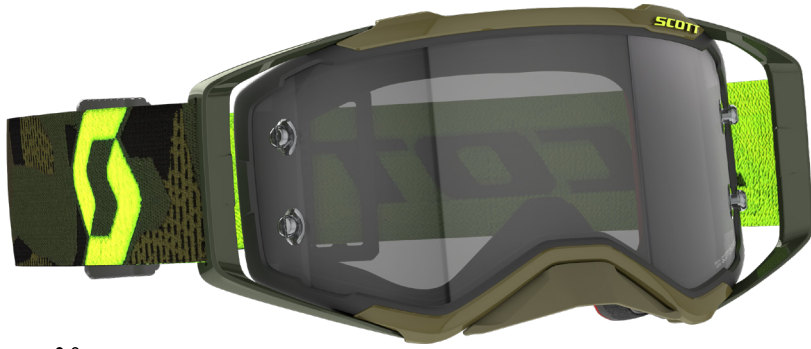

kaki green/neon yellow | light sensitive grey works
7701327

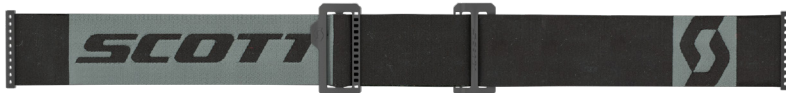

black/grey | light sensitive grey works
1001327



goggle bag



noseguard

▶ SIMON LÄNGENFELDER



DEFEND YOUR VISION

NO SHORTCUTS

—

PROSPECT

Boasting a massive field of Vision, articulating outriggers, No Sweat face foam, a 50mm strap and SCOTT's proprietary lens lock system, the Prospect goggle delivers on all fronts. Allow the SCOTT Prospect to Defend Your Vision during your unwavering pursuit of victory.



PROSPECT

THE NO. 1 CHOICE FOR CHALLENGING CONDITIONS.

When it comes to racing on wet or muddy tracks, the Prospect WFS goggle is the only real choice. The race-proven, precision-engineered WFS50 system combined with the massive field of vision leaves all other goggles scrambling for second place.



CLICK-ON CANISTER

No need for tools, no need to waste time; simply click the canisters onto the WORKS pins and ride. The red lever makes sure the canister is safely attached. This system is the ultimate in WORKS technology.



LARGE 50 MM FILM

The SCOTT WFS50 is the largest film on the market, measuring a massive 50 millimeters. Combined with a thin frame construction, it offers up to 50 clear views even in the most challenging conditions.



ANTI-STICK GRID AND TRANSPARENT MUDFLAP

A large film requires an optimized anti-stick grid with mudflap. A thin vertical line has been added in the middle of the grid to make sure the film never sticks to the lens.



The SCOTT Prospect WFS Goggle is the perfect solution for racing in wet and muddy conditions. It comes equipped with a WFS50 roll-off system for a large and clear field of vision when the mud starts spraying. The canisters can be clipped directly on the WORKS lens pins for quick and easy installation, with no tools required. Tear-offs can then be easily installed on the same pins for extra vision protection. The transparent anti-stick grid offers a superior field of vision, smooth sliding on the lens and a better sealing with the lens at the top.

FRAME TECHNOLOGIES

- WFS50 Roll-off system
- SCOTT anti-stick grid with mudflap
- Lens Lock System
- NoSweat 3-layer molded face foam
- Articulated outriggers
- Extra wide no-slip silicone strap

LENS TECHNOLOGIES

- 100% UV Protection
- NoFog™ Anti-Fog lens treatment
- Single Lens Works

EXTRAS:

- Microfiber Goggle bag
- Noseguard
- + 2 rolls of Film



grey/orange | clear works
1294113



2 rolls of film



goggle bag



noseguard



premium black/white | clear works
7702113

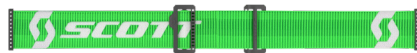

green/white | clear works
1075113



red/black | clear works
1018113

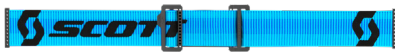

blue/black | clear works
1034113

PROSPECT

A PRO-LEVEL GOGGLE FOR RIDERS THAT DEMAND THE BEST.

Previously only available to our pro team riders, the SCOTT engineers have spared no expense in their quest to make the Prospect Super WFS the ultimate motocross racing goggle. With exclusive features and premium components, this goggle is as good as it gets.

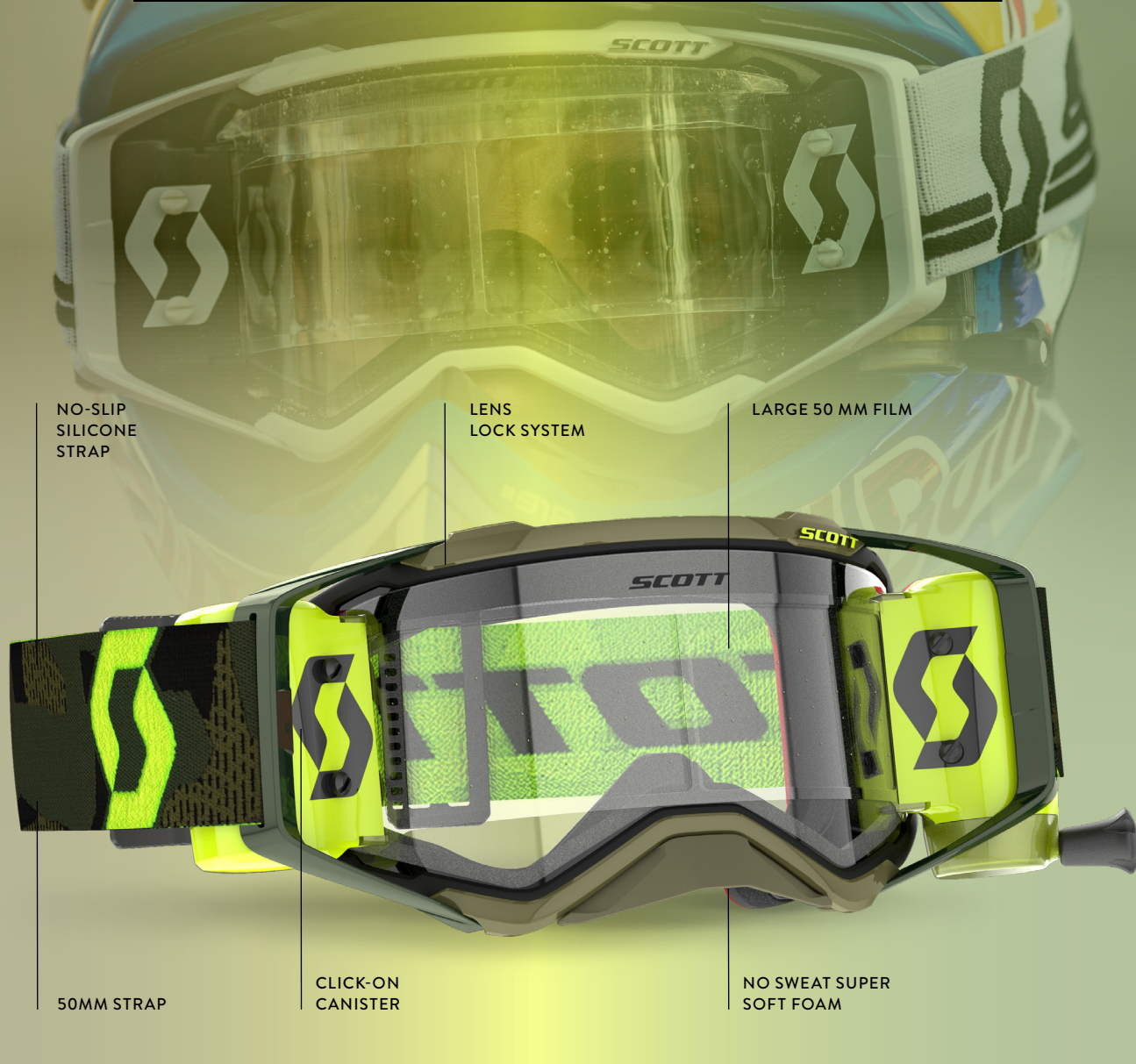

NO-SLIP SILICONE STRAP

LENS LOCK SYSTEM

LARGE 50 MM FILM

50MM STRAP

CLICK-ON CANISTER

NO SWEAT SUPER SOFT FOAM

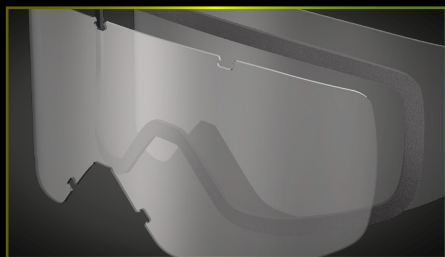

DOUBLE LENS

Spacer Foam and Double Lens block moisture and eliminate fogging while allowing for optimal breathability.

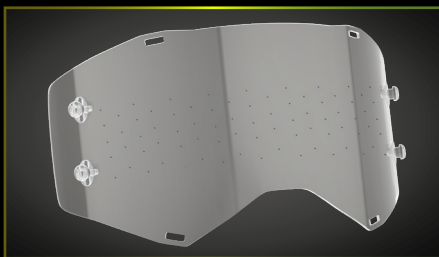

PERFORATED ANTI-STICK DOTS ON LENS

To ensure the smoothest film transfer possible, anti-stick dots on the lens provide pro-level performance when you need it most.



WFS MUDFLAP WITH SEALING TAPE

Specifically designed to create the ultimate seal to keep out any unwanted water drops.



The SCOTT Prospect Super WFS is the ultimate motocross racing goggle. It possesses the same great features as the Prospect WFS, but the Super WFS version features a double WORKS lens with the unique addition of premium anti-stick dots for hyper-smooth sliding action and an upgraded mudflap with sealing tape for maximum performance. It comes equipped with a WFS50 roll-off system for a large and clear field of vision when the mud starts spraying. The canisters can be clipped directly on the WORKS lens pins for quick and easy installation, with no tools required. Tear-offs can then be easily installed on the same pins for extra vision protection.

FRAME TECHNOLOGIES

- WFS50 Roll-off system
- SCOTT anti-stick grid mudflap with sealing tape
- Lens Lock System
- NoSweat 3-layer molded face foam
- Articulated outriggers
- Extra wide no-slip silicone strap

LENS TECHNOLOGIES

- 100% UV Protection
- Anti-Stick Dots
- Double Lens Works
- NoFog™ Anti-Fog lens treatment

EXTRAS:

- Microfiber Goggle bag
- Noseguard
- + 2 rolls of Film

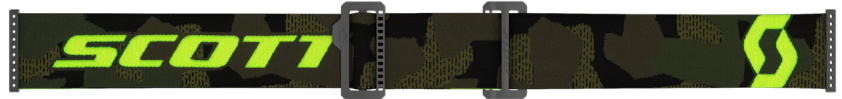

kaki green/neon yellow | clear works
770113



2 rolls of film



goggle bag



noseguard

PROSPECT

OPTIMAL PERFORMANCE WITH ENDURO-SPECIFIC FEATURES.

Designed to perform in the toughest conditions on the planet, the Prospect Enduro features a double lens and an air control ventilation system to ensure your vision remains crystal clear no matter where you find yourself riding.

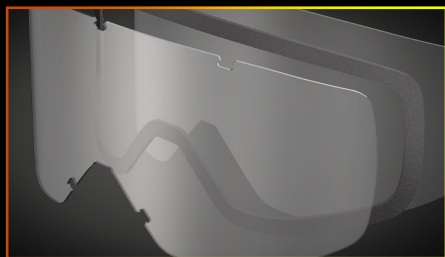
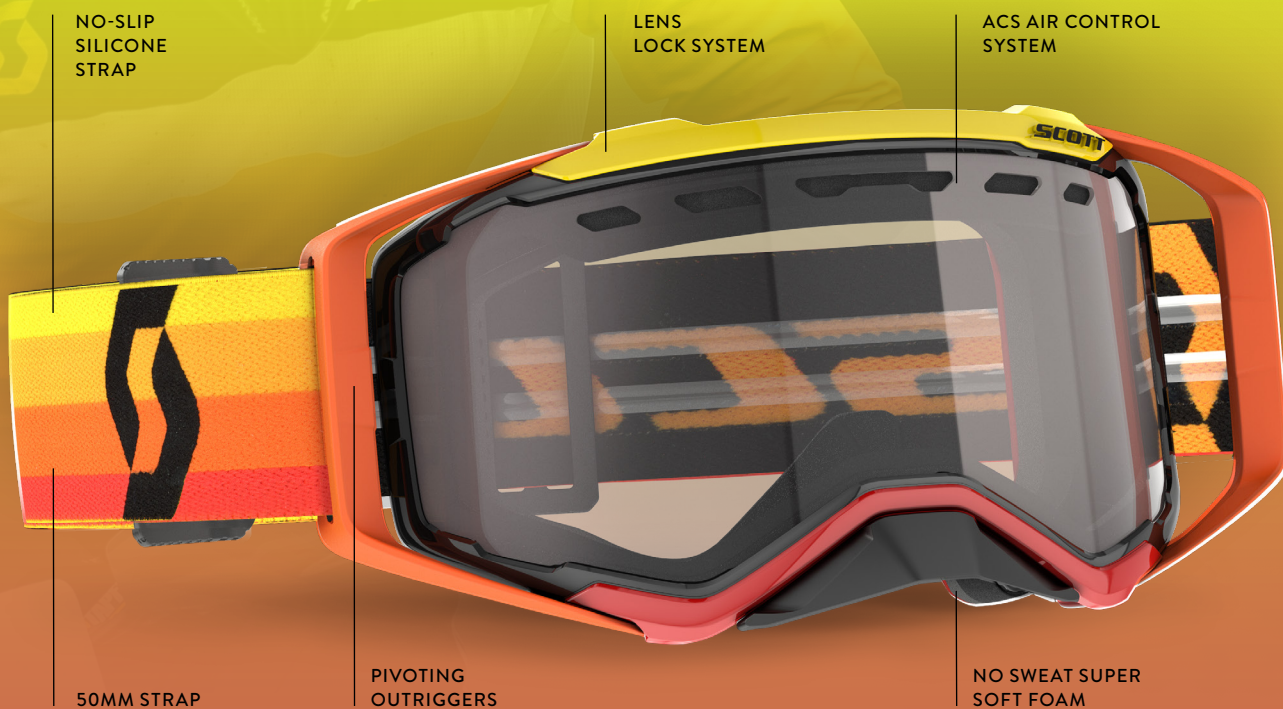

DOUBLE LENS

Spacer Foam and Double Lens block moisture and eliminate fogging while allowing for optimal breathability.

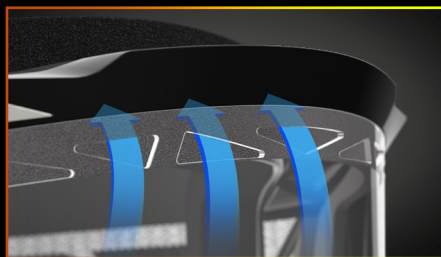

AIR CONTROL SYSTEM (ACS)

ACS ventilation incorporates lens air intake vents on the goggle lens and frame air outtake vents on the bottom of the goggle resulting in a sophisticated ventilation system against condensation and fogging.



ANTI-FOG ON INNER LENS

Enduro double lenses include a soft inner lens which features a stronger built-in anti-fog solution than any other SCOTT lens. When riding Enduro races fog should never be an obstacle.



The SCOTT Prospect Enduro Goggle is designed specifically for the modern enduro rider. Boasting the same great features as the Prospect, it also comes with a double lens with Air Control System that prevents fogging and gives the enduro rider extra-clear vision in low-speed situations. In addition, it features an innovative SCOTT Lens Lock System and NoSweat face foam. To avoid slipping of the goggle, it is equipped with an extra-wide, no-slip silicone strap. This strap, together with the articulated outriggers, highly contribute to the improved helmet integration.

FRAME TECHNOLOGIES

- Lens Lock System
- NoSweat 3-layer molded face foam
- Articulated outriggers
- Extra wide no-slip silicone strap

LENS TECHNOLOGIES

- 100% UV Protection
- ACS Air Control System
- Double Lens
- NoFog™ Anti-Fog lens treatment

EXTRAS:

- Microfiber Goggle bag
- Noseguard



orange/yellow | clear
1649043



goggle bag



noseguard



The SCOTT Prospect Enduro Light Sensitive Goggle boasts the same great features as the Prospect Enduro Goggle: a large field of vision, Lens Lock System, NoSweat face foam, pivoting outriggers, double lens with Air Control System and much more. What makes this goggle so special is the Light Sensitive double lens, which adapts automatically to sunlight intensity. With this lens, there's no question you're equipped for all light conditions.

FRAME TECHNOLOGIES

- Lens Lock System
- NoSweat 3-layer molded face foam
- Articulated outriggers
- Extra wide no-slip silicone strap

LENS TECHNOLOGIES

- 100% UV Protection
- ACS Air Control System
- Double Lens
- NoFog™ Anti-Fog lens treatment
- SCOTT Light Sensitive photochromic lens technology

EXTRAS:

- Microfiber Goggle bag
- Noseguard

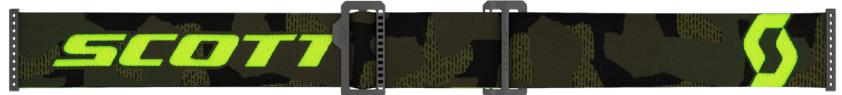
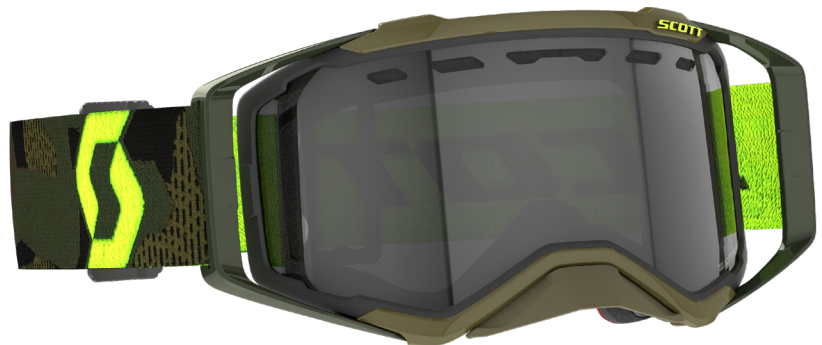

kaki green/neon yellow | light sensitive grey
7701343



goggle bag



noseguard

PROSPECT

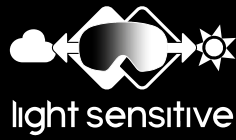

light sensitive

DESIGNED TO DEFEND YOUR VISION FROM THE SMALLEST GRAINS OF SAND.

In the desert or on the beach, the Prospect Sand Dust LS is constructed with specifically engineered foam that ensures the sand stays out of your eyes. Paired with a Light Sensitive lens which adapts to sunlight intensity, this is the ultimate goggle for all sand-based riding.



NO-SLIP SILICONE STRAP

LENS LOCK SYSTEM

MASSIVE FIELD OF VISION

50MM STRAP

PIVOTING OUTRIGGERS

NO SWEAT SUPER SOFT FOAM

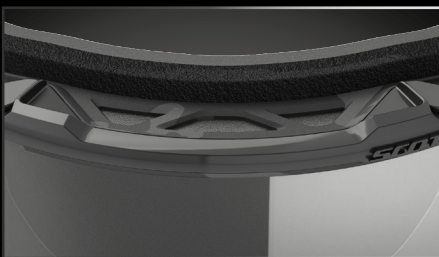

SMALL PARTICLE VENT FOAM MEMBRANE

To avoid any sand or dust-sized particles getting into the frame, all SCOTT Sand Dust goggles are mounted with a closed cell membrane instead of the traditional open cell vent foam. This technology guarantees perfect isolation from the elements.

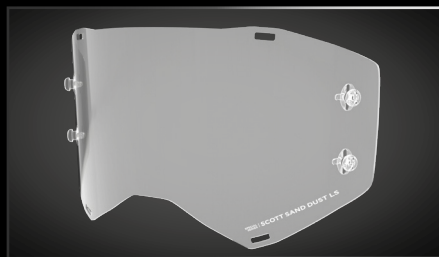

LIGHT SENSITIVE LENS CAT. 1-2

SCOTT Light Sensitive lenses engage photochromic technology and adapt automatically to sunlight intensity. These lenses react to light changes and within seconds the lens will darken when the brightness gets stronger or lighten when the sunlight gets weaker.



LENS LOCK SYSTEM

With this feature SCOTT guarantees the safest lens retention on the market. It features 4 locking pins that go through the lens keeping the lens in no matter what.



The SCOTT Prospect Sand Dust Light Sensitive Goggle has been specifically designed for use on beaches, in deserts and out in the dunes. The already exceptional features of the Prospect goggle are paired with the revolutionary Dust Catcher foam. Ride freely without worrying about even the smallest dust or sand particles getting inside your goggles. This assurance, combined with a large field of vision, the innovative SCOTT Lens Lock System, articulated outriggers and a Light Sensitive lens that adapts automatically to sunlight, are everything you need for your next ride.

FRAME TECHNOLOGIES

- Lens Lock System
- NoSweat 3-layer molded face foam
- Articulated outriggers
- Extra wide no-slip silicone strap
- Dust catcher Ventfoam

LENS TECHNOLOGIES

- 100% UV Protection
- Single Lens Works
- NoFog™ Anti-Fog lens treatment
- SCOTT Light Sensitive photochromic lens technology

EXTRAS:

- Microfiber Goggle bag
- Noseguard



premium black/white | light sensitive grey works
7702327



goggle bag



noseguard

FURY.

LOW PROFILE, HIGH PERFORMANCE.

The younger brother of the Prospect, the Fury is a lightweight option that doesn't compromise on safety or style. Pushing the limits of field of vision, comfort and lens retention, the Fury is a perfect choice for all levels of rider.



NO-SLIP SILICONE STRAP

LENS LOCK SYSTEM

MASSIVE FIELD OF VISION

WFS50 ROLL-OFF SYSTEM COMPATIBLE

3-LAYER MOLDED FACE FOAM

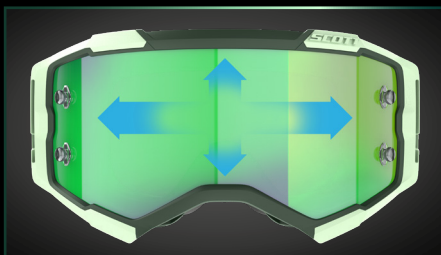

MASSIVE FIELD OF VISION

Carrying the same lens as the Prospect goggle, we are proud to say that the Fury offers the largest field of vision on the market. The large lens combined with a thin frame construction brings the lens closer to your eyes, maximizing the overall field of vision.

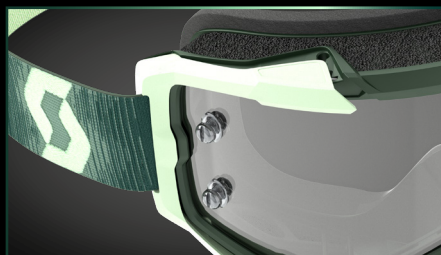

LENS LOCK SYSTEM

Transferred from the Prospect to the Fury Goggle, our innovative Lens Lock System is another highlight that distinguishes this new goggle. With the Lens Lock System it guarantees you the safest lens retention on the market and enables you to change your lens anywhere anytime.

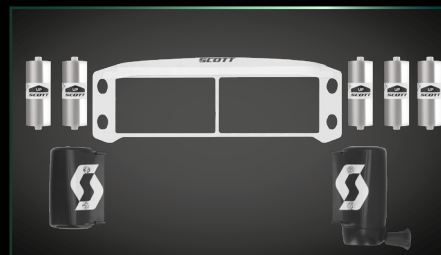

PROSPECT ACCESSORY COMPATIBLE

WFS 50, lens, anti-stick grid or mudflap – any of these accessories can be used for both our Fury and Prospect Goggle. This makes it very convenient to switch from one goggle to the other without worrying about the right accessories.



The SCOTT Fury Goggle is guaranteed to shake things up. Shaped by innovation, technology and design, the Fury follows in the steps of our flagship goggle, the Prospect. Featuring our proven SCOTT Lens Lock System, 3-layer face foam, no-slip silicone strap, and supporting all the same accessories as the Prospect, this low-profile, high-performance motocross goggle was fully developed to Defend Your Vision in any and all conditions.

FRAME TECHNOLOGIES

- Lens Lock System
- 3-layer molded face foam
- No-slip silicone strap

LENS TECHNOLOGIES

- 100% UV Protection
- NoFog™ Anti-Fog lens treatment
- Single Lens Works

EXTRAS:

- Bonus Clear lens included

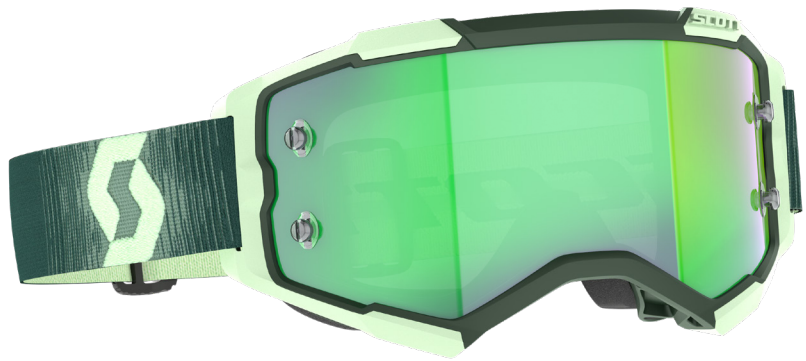

dark green/mint green | green chrome works
7703279



clear lens

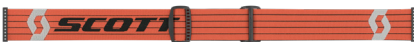
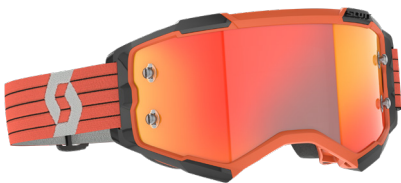

orange/grey | orange chrome works
1011280



premium black/white | purple chrome works
7702281

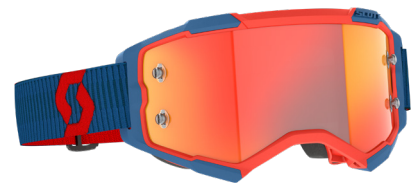

dark blue/neon red | orange chrome works
7698280

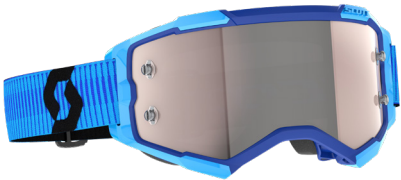

blue/black | silver chrome works
1034269



dark yellow/dark blue | blue chrome works
7704349

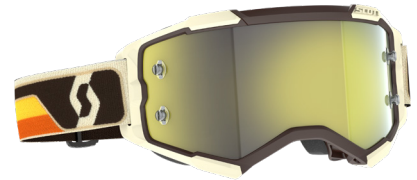

deep brown/beige | yellow chrome works
7699289



white | blue chrome works
0002349



premium black/white | light sensitive grey works
7702327



light grey/neon yellow | light sensitive grey works
7697327



The SCOTT Fury Light Sensitive Goggle is guaranteed to shake things up. Shaped by innovation, technology and design, the Fury follows in the steps of our flagship goggle, the Prospect. Featuring our proven SCOTT Lens Lock System, 3-layer face foam, no-slip silicone strap, and supporting all the same accessories as the Prospect, this goggle was developed to Defend Your Vision. What makes the Fury LS so special is the Light Sensitive lens, which engages photochromic technology and adapts automatically to sunlight intensity. So you have one versatile lens for all weather conditions.

FRAME TECHNOLOGIES

- Lens Lock System
- 3-layer molded face foam
- No-slip silicone strap

LENS TECHNOLOGIES

- 100% UV Protection
- NoFog™ Anti-Fog lens treatment
- SCOTT Light Sensitive photochromic lens technology
- Single Lens Works

SCOTT FURY WFS GOGGLE



dark blue/neon red | clear works
7698113



premium black/white | clear works
7702113



blue/black | clear works
1034113



The SCOTT Fury WFS comes equipped with all the same great features as the standard Fury. This upgraded version comes with a pre-installed WFS50 roll-off system, offering a large, clear field of vision even in the muddiest conditions. The canisters can be clipped directly on the WORKS pins of the lens, which makes their installation much easier and less time-consuming. It takes almost no effort as there are no tools required. It also makes the switch from roll-off to tear-off simple and fast. The improved, transparent anti-stick grid offers a better field of vision, easier installation in the canisters, better sliding on the lens and better sealing with the lens at the top.

FRAME TECHNOLOGIES

- WFS50 Roll-off system
- SCOTT anti-stick grid with mudflap
- Lens Lock System
- 3-layer molded face foam
- No-slip silicone strap

LENS TECHNOLOGIES

- 100% UV Protection
- NoFog™ Anti-Fog lens treatment
- Single Lens Works

EXTRAS:

- + 2 rolls of Film
- Extra pin



2 rolls of film



The SCOTT Fury Enduro Goggle is designed specifically for the modern enduro rider. Boasting the same great features as the standard Fury, this Enduro model also comes with a double lens with Air Control System that prevents fogging and gives the enduro rider extra-clear vision in low-speed situations. In addition, the Fury Enduro goggle also features our proven SCOTT Lens Lock System, 3-layer face foam, a massive field of vision and a no-slip silicone strap. Supporting all the same lens accessories as the Prospect, this low-profile, high-performance goggle will Defend Your Vision in any and all conditions.

FRAME TECHNOLOGIES

- Lens Lock System
- 3-layer molded face foam
- No-slip silicone strap

LENS TECHNOLOGIES

- 100% UV Protection
- ACS Air Control System
- Double Lens
- NoFog™ Anti-Fog lens treatment



light grey/neon yellow | clear
7697043

PRIMAL

THE PRIMAL COMBINES CLEAN, TIMELESS STYLE WITH ULTIMATE VALUE.

The Primal goggle has been engineered to be the ultimate entry-level moto goggle. Designed to offer great features at an affordable price, the stylish, comfortable and extremely functional Primal goggle offers a whole lot of bang for your buck.



NO-SLIP SILICONE STRAP

SINGLE WORKS LENS

2-LAYER FACE FOAM

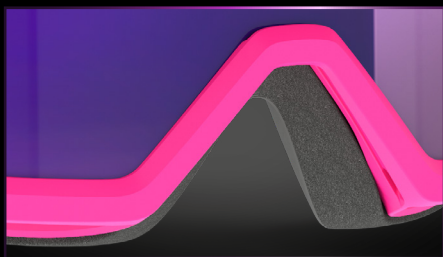

2-LAYER FACE FOAM

Open-celled face foam with excellent moisture-absorbing and thermal properties, guaranteeing you stay dry and comfortable all day.



NOFOG™ ANTI-FOG LENS TREATMENT

A permanent No Fog™ treatment process prevents condensation and fogging, keeping your vision clear.



SCOTT TRUVIEW SINGLE WORKS LENS

Lightweight and featuring two single WORKS pins for tear-off. Blocks 100% of harmful UV rays.



The SCOTT Primal Goggle is the latest addition to the SCOTT off-road goggle range. With its perfect blend of simplicity and style, this goggle is ideal for newcomers and experienced riders on a budget. With features such as 2-layer face foam, a chrome SCOTT TruView single WORKS lens and NoFog™ Anti-Fog lens treatment, the Primal follows in the footsteps of its big brothers, the Prospect and the Fury. Optimized for smaller faces, the Primal packs a real punch and is available at an unbeatable price.

FRAME TECHNOLOGIES

- 2-layer face foam
- No-slip silicone strap

LENS TECHNOLOGIES

- 100% UV Protection
- NoFog™ Anti-Fog lens treatment
- Single Lens Works

FIT:

- Optimized for smaller faces



pink/black | purple chrome works
1665281



black/white | silver chrome works
1007269



blue/white | blue chrome works
1006349



orange/white | orange chrome works
1362280



red/white | orange chrome works
1005280



yellow/black | yellow chrome works
1017289



white | silver chrome works
0002269



The SCOTT Primal Clear Goggle is the latest addition to the SCOTT off-road goggle range. This simple and stylish goggle is perfect for newcomers and experienced riders on a budget. With features such as a SCOTT TruView clear lens and NoFog™ Anti-Fog lens treatment, the Primal Clear follows in the footsteps of its big brothers, the Prospect and the Fury. Optimized for smaller faces, the Primal Clear packs a real punch and is available at an unbeatable price.

FRAME TECHNOLOGIES

- 2-layer face foam
- No-slip silicone strap

LENS TECHNOLOGIES

- 100% UV Protection
- NoFog™ Anti-Fog lens treatment
- Single Lens Works

FIT:

- Optimized for smaller faces



white | clear works
0002113



black/white | clear works
1007113



blue/white | clear works
1006113



orange/white | clear works
1362113



red/white | clear works
1005113



yellow/black | clear works
1017113



pink/black | clear works
1665113



The SCOTT Primal Enduro Goggle comes equipped with all the same great features as the standard Primal, but has been designed specifically for new and experienced enduro riders on a budget. Following in the footsteps of its big brother, the Prospect Enduro, the Primal Enduro features an upgraded SCOTT TruView double lens as well as the ACS Air Control System to help prevent fogging. The Primal Enduro has been optimized for smaller faces and is available at an unbeatable price.

FRAME TECHNOLOGIES

- 2-layer face foam
- No-slip silicone strap

LENS TECHNOLOGIES

- 100% UV Protection
- ACS Air Control System
- Double Lens
- NoFog™ Anti-Fog lens treatment

FIT:

- Optimized for smaller faces



light grey/neon yellow | clear
7697043



black/white | clear
1007043



white | clear
0002043

SCOTT PRIMAL SAND DUST GOGGLE



The SCOTT Primal Sand Dust Goggle comes equipped with the same great features as the standard Primal, but has been designed specifically for use in sandy conditions. Following in the footsteps of its big brother, the Prospect Sand Dust, the Primal Sand Dust features an upgraded Dust Catcher vent foam to help keep the sand out of your eyes. The Primal Sand Dust has been optimized for smaller faces and is available at an unbeatable price.

FRAME TECHNOLOGIES

- 2-layer face foam
- No-slip silicone strap
- Dust catcher Ventfoam

LENS TECHNOLOGIES

- 100% UV Protection
- NoFog™ Anti-Fog lens treatment
- Single Lens

FIT:

- Optimized for smaller faces



black/white | dark grey
1007053



light grey/neon yellow | dark grey
7697053



The SCOTT Primal Youth Goggle is designed specifically for the next generation of champions. With great features such as a SCOTT TruView clear lens, Impact Resistant lenses and NoFog™ Anti-Fog lens treatment, the Primal Youth follows in the footsteps of its big brothers, the Prospect and the Fury by offering the best vision in its class. Optimized for smaller faces, this youth motocross goggle packs a real punch and is available at an unbeatable price.

FRAME TECHNOLOGIES

- Single-layer face foam
- No-slip silicone strap

LENS TECHNOLOGIES

- 100% UV Protection
- NoFog™ Anti-Fog lens treatment
- Single Lens

FIT:

- Optimized for smaller faces

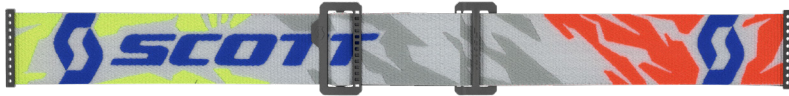

pink | clear
0026043

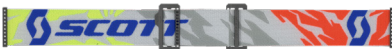

black | clear
0001043



blue | clear
0003043



red | clear
0004043



orange | clear
0036043

SPLIT



THE ULTIMATE GOGGLE FOR WEARING OVER THE GLASSES.

The **SCOTT Split OTG Goggle** is the ultimate goggle for wearing over the glasses. A new integrated **RAM Air System** dictates the flow of air coming into the goggle through the top spoiler to ensure the lenses don't steam up and stay crystal clear all day long.



OPTIMIZED FOR
PRESCRIPTION
GLASSES

INTEGRATED RAM AIR
SYSTEM

NO-SLIP
SILICONE STRAP

3-LAYER
FACE FOAM

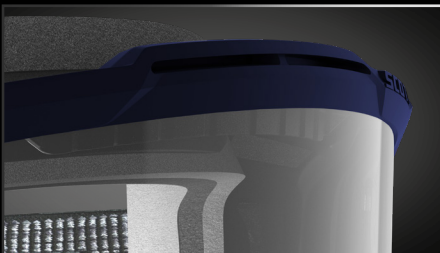

INTEGRATED RAM AIR SYSTEM

This innovative new intake system is engineered specifically to increase air-flow to reduce the risk of your glasses or goggle lenses fogging up.

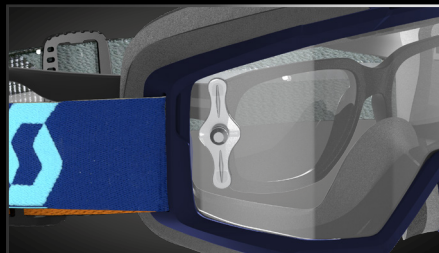

OPTIMIZED FOR PRESCRIPTION GLASSES

Specially designed to offer maximum comfort and an ergonomic, secure fit when worn over your regular prescription glasses.

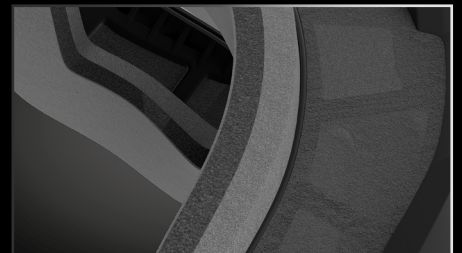

3-LAYER FACE FOAM

SCOTT's 3-Layer Face Foam incorporates three layers of foam to provide maximum comfort and help wick away moisture.



The new and fully updated SCOTT Split OTG Goggle is the ultimate goggle for wearing over the glasses. A new integrated RAM Air System dictates the flow of air coming into the goggle through the top spoiler to ensure the lenses don't steam up and stay crystal clear all day long. Combined with 3-layer face foam, SCOTT's NoFog™ Anti-Fog lens treatment and a fit that has been specifically designed to be worn with glasses, the new Split OTG makes riding in glasses a breeze.

FRAME TECHNOLOGIES

- 3-layer face foam
- No-slip silicone strap
- Integrated RAM Air System

LENS TECHNOLOGIES

- 100% UV Protection
- NoFog™ Anti-Fog lens treatment
- Single Lens Works

FIT:

- Optimized for prescription glasses



premium black/white | clear works
7702113



blue/black | clear works
1034113



white | clear works
0002113



dark blue/neon red | clear works
7698113



light grey/neon yellow | clear works
7697113

89X ERA

ULTIMATE STYLE IN THE DIRT OR ON THE STREETS

Back by popular demand, The SCOTT 89X Era goggle is a true revival of the original and much-loved SCOTT 89 series goggle from back in the day, with a few cool twists of course!



EXTRA WIDE
NO-SLIP
SILICONE
STRAP

CLASSIC SCOTT
STYLE

CHROME
LENS

NOFOG™
ANTI-FOG LENS

2-LAYER
FACE FOAM



HERITAGE BRANDING

The branding on the 89X Era goggle uses SCOTT's old heritage logo, as found on the original 89 series goggles.

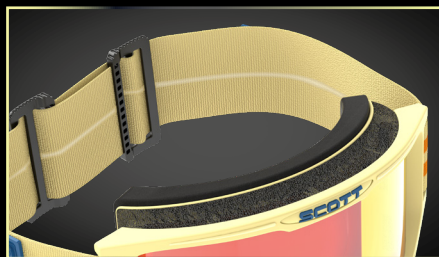

NO-SLIP SILICONE STRAP

Adhered silicone strips on the inside of the goggle strap ensures the goggles stay in place on your helmet.

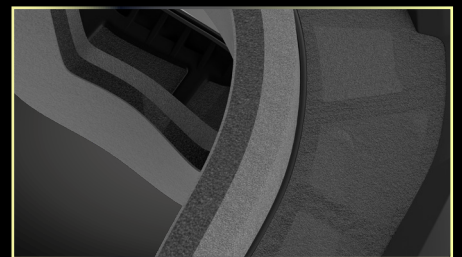

2-LAYER FACE FOAM

Open-celled face foam with excellent moisture-absorbing and thermal properties, guaranteeing you stay dry and comfortable all day.



The SCOTT 89X Era goggle combines classic moto style with modern performance features. Stopped in heritage, this goggle is a true revival of the original and much-loved SCOTT 89 series goggle from back in the day, with a few cool twists of course! The strap has been fully updated with new materials including silicon lining and premium branding. Fitted with a stunning chrome lens as standard and featuring 100% UV Protection and anti-fog lens treatment, you don't have to worry about your vision in the dirt or on the streets. Finished with exceptional painting detail and unique designs, the 89X Era is the no. 1 choice for that real retro look!

FRAME TECHNOLOGIES

- 2-layer face foam
- Extra wide no-slip silicone strap

LENS TECHNOLOGIES

- 100% UV Protection
- NoFog™ Anti-Fog lens treatment

EXTRAS:

- Bonus Clear lens included

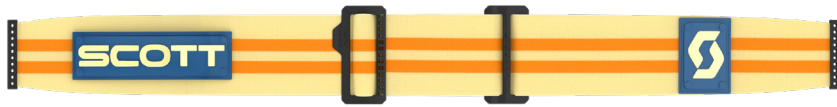

beige | orange chrome
0009287



clear lens



blue/white | yellow chrome
1006179



black/beige | silver chrome
1098015



brown | silver chrome
0008015



GOGGLES OVERVIEW

PROSPECT

285536
PROSPECT AMP GOGGLE



blue/orange | blue chrome works
1454349



grey/orange | gold chrome works
1294324

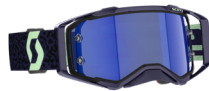

dark purple/mint green | blue chrome works
7696349



white/black | gold chrome works
1035324



grey/orange | rose works
1294352



blue/orange | rose works
1454352

272821
PROSPECT GOGGLE



dark purple/mint green | rose works
7696352



white/black | rose works
1035352

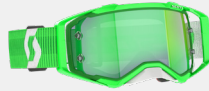

green/white | green chrome works
1075279



red/black | silver chrome works
1018269



blue/black | blue chrome works
1034349



orange/yellow | orange chrome works
1649280

272820
PROSPECT LIGHT SENSITIVE GOGGLE



premium black/white | purple chrome works
7702281



beige/brown | silver chrome works
1074269

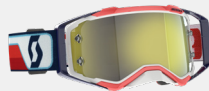

red/white | yellow chrome works
1005289



black/grey | green chrome works
1001279



kaki green/neon yellow | light sensitive grey works
7701327



black/grey | light sensitive grey works
1001327

272822
PROSPECT WFS GOGGLE



grey/orange | clear works
1294113



blue/black | clear works
1034113



premium black/white | clear works
7702113



green/white | clear works
1075113



red/black | clear works
1018113



kaki green/neon yellow | clear works
7701113

278595
PROSPECT SUPER WFS GOGGLE

272825
PROSPECT ENDURO GOGGLE



orange/yellow | clear
1649043

272824
ENDURO LIGHT SENSITIVE GOGGLE



kaki green/neon yellow | light sensitive grey
7701343

272826
PROSPECT SAND DUST LIGHT SENSITIVE GOGGLE



premium black/white | light sensitive grey works
7702327

FURY

272828
FURY GOGGLE

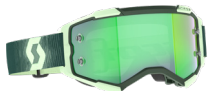

dark green/mint green | green chrome works
7703279



orange/grey | orange chrome works
1011280



premium black/white | purple chrome works
7702281

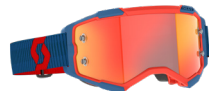

dark blue/neon red | orange chrome works
7698280

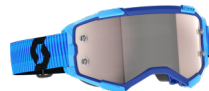

blue/black | silver chrome works
1034269

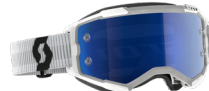

white | blue chrome works
0002349

272827
FURY LIGHT SENSITIVE GOGGLE



dark yellow/dark blue | blue chrome works
7704349

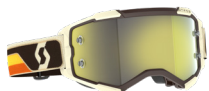

deep brown/beige | yellow chrome works
7699289



premium black/white | light sensitive grey works
7702327



light grey/neon yellow | light sensitive grey works
7697327

278596
FURY WFS GOGGLE



dark blue/neon red | clear works
7698113



premium black/white | clear works
7702113

403265
FURY ENDURO GOGGLE



blue/black | clear works
1034113



light grey/neon yellow | clear
7697043

PRIMAL

278597
PRIMAL GOGGLE



pink/black | purple chrome works 1665281 black/white | silver chrome works 1007269 blue/white | blue chrome works 1006349 orange/white | orange chrome works 1362280 red/white | orange chrome works 1005280 yellow/black | yellow chrome works 1017289

278598
PRIMAL CLEAR GOGGLE



white | silver chrome works 0002269 white | clear works 0002113 black/white | clear works 1007113 blue/white | clear works 1006113 orange/white | clear works 1362113 red/white | clear works 1005113

278599
PRIMAL ENDURO GOGGLE



yellow/black | clear works 1017113 pink/black | clear works 1665113 white | clear 0002043 black/white | clear 1007043 light grey/neon yellow | clear 7697043 black/white | dark grey 1007053

278600
PRIMAL SAND DUST GOGGLE

403026
PRIMAL YOUTH GOGGLE



light grey/neon yellow | dark grey 7697053 orange | clear 0036043 black | clear 0001043 blue | clear 0003043 red | clear 0004043 pink | clear 0026043

SPLIT OTG

285537
SPLIT OTG GOGGLE



white | clear works 0002113 blue/black | clear works 1034113 premium black/white | clear works 7702113 dark blue/neon red | clear works 7698113 light grey/neon yellow | clear works 7697113

89X ERA

411703
89X ERA GOGGLE







beige | orange chrome 0009287 blue/white | yellow chrome 1006179 black/beige | silver chrome 1098015 brown | silver chrome 0008015



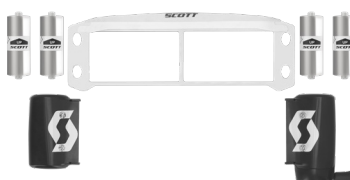
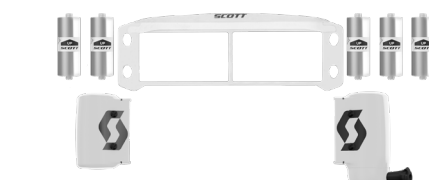
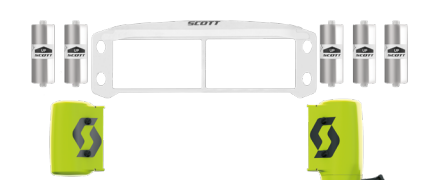



GOGGLE ACCESSORIES

■ PROSPECT / FURY

WORKS FILM SYSTEM (WFS) (INCLUDES: WORKS ANTI-STICK GRID, WORKS CANISTER, FILM REFILLS)







<p>248782 WFS50 ROLL-OFF KIT PROSPECT/FURY BLACK</p>	<p>285679 WFS50 ROLL-OFF KIT PROSPECT/FURY WHITE</p>	<p>265915 WFS50 ROLL-OFF KIT PROSPECT/FURY YELLOW</p>	
			
<p>248789 WFS50 ROLL-OFF SUPPLYSIDE CANISTER PROSPECT/FURY</p>	<p>248788 WFS50 ROLL-OFF MOTORSIDE CANISTER PROSPECT/FURY</p>	<p>248790 WFS ANTI-STICK GRID PROSPECT/FURY (3-PACK) 285680 WFS ANTI-STICK GRID + SEALING TAPE PROSPECT/FURY (2-PACK)</p>	<p>248787 WFS50 ROLL-OFF REFILLS PROSPECT/FURY (12-PACK)</p>
			

FRAME REPLACEMENTS / PINS / TEAR-OFFS

<p>268403 WFS50 - RED LOCKER (5 PAIRS)</p>	<p>268418 PROSPECT TOP AND BOTTOM BAR</p>	<p>268419 PROSPECT OUTRIGGERS</p>	<p>268416 PROSPECT/FURY LENS PINS (10-PACK)</p>	<p>273572 TEAR-OFF PROSPECT/FURY (20-PACK)</p>	<p>273573 LAMINATED TEAR-OFF PROSPECT/FURY (2 PACKS OF 7)</p>	<p>268414 PROSPECT STRAP TEAR OFF TAB 50MM (10-PACK)</p>
						

NOSEGUARDS

GOGGLE POUCH

<p>273574 FURY WORKS TEAR-OFF TAB 40MM</p>	<p>287956 LAM TEAR OFF PROSPECT/FURY 2 PACKS OF 7 ONE SIZE</p>	<p>248794 PROSPECT NOSEGUARD</p>	<p>273575 FURY NOSEGUARD</p>	<p>267690 GOGGLE POUCH PAK-50</p>	<p>403977 GOGGLE POUCH PAK-5</p>
					

■ PRIMAL / HUSTLE / TYRANT / SPLIT / BUZZ / 80 SERIES

WORKS FILM SYSTEM (WFS) (INCLUDES: WORKS ANTI-STICK GRID, WORKS CANISTER, FILM REFILLS)

248783
WFS ROLL-OFF KIT HUSTLE/PRIMAL/SPLIT OTG BLACK



248784
WFS ROLL-OFF KIT RECOIL BLACK



248785
WFS ROLL-OFF KIT BUZZ BLACK



205171
30MM WFS ROLL-OFF
SUPPLYSIDE CANISTER



205170
30MM WFS ROLL-OFF
MOTORSIDE CANISTER



248791
WFS ANTI-STICK GRID HUSTLE/PRIMAL/SPLIT OTG (3-PACK)
248792
WFS ANTI-STICK GRID RECOIL (3-PACK)
248793
WFS ANTI-STICK GRID BUZZ (3-PACK)



205169
30MM WFS ROLL-OFF REFILLS (12-PACK)



TEAR-OFFS / PINS

219690
PRIMAL/HUSTLE MX
TEAR-OFF PAK-20



219692
HOLESOT TEAR-OFF
PRIMAL/HUSTLE (10-
PACK)



240934
PRIMAL/HUSTLE
LAMINATED TEAR-
OFF (2 PACKS OF 7)



268417
PRIMAL/HUSTLE/
SPLIT OTG LENS PINS
(10-PACK)



248781
TEAR-OFF BUZZ (20-
PACK)



205159
TEAR-OFF 80'S (20-
PACK)



240935
LAMINATED TEAR-
OFF 80'S (2 PACKS
OF 7)



216634
TEAR-OFF 89SI (20-
PACK)



273574
89SI WORKS TEAR-OFF
TAB 40MM



205162
HOLESOT TEAR-OFF
PROA/VOLT/80 (10-PACK)



NOSEGUARDS

219694
HUSTLE NOSEGUARD



219696
RECOIL NOSEGUARD

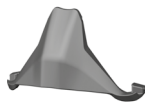

230124
SPLIT OTG NOSEGUARD
(SUITABLE FOR SPLIT OTG
UP TO MODEL 2020)



FACEMASKS

225554
TYRANT FACEMASK

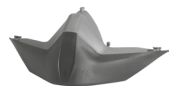

278739
PRIMAL/SPLIT OTG
FACEMASK
(SUITABLE FROM MODEL
2021)

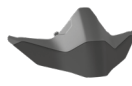

278740
PRIMAL / SPLIT SAFARI
FACEMASK



219695
HUSTLE FACEMASK

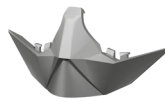

219697
RECOIL FACEMASK

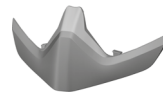

230124
SPLIT OTG FACEMASK

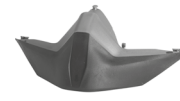

205176
VENTURI FACEGUARD
(W/ FACE FOAM)



REPLACEMENT LENSES

■ PROSPECT / FURY

SINGLE LENS

285677 MX PROSPECT/
FURY AMP
LENS



gold chrome afc works
323



rose afc works
354



blue chrome afc works
356

248776 MX
PROSPECT/FURY SNG
WORKS LENS



clear afc works
102



electric blue chrome afc
works
282



orange chrome afc works
283



green chrome afc works
284



purple chrome afc works
285

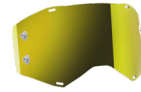

yellow chrome afc works
301



silver chrome afc works
321



pink chrome afc works
344

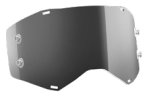

light sensitive grey afc
works
328

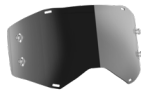

dark grey afc works
345

265610 MX
PROSPECT/FURY
ANTI-STICK SGL WKS
LENS



clear anti-stick works
332

■ PROSPECT / FURY

DOUBLE LENS

265518 MX
PROSPECT/FURY DL
WORKS LENS



clear afc works
102

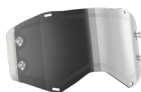

light sensitive grey afc works
328



grey afc works
330

265519 MX
PROSPECT/FURY DL
ACS LENS

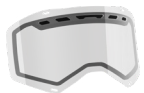

clear afc
041



light sensitive grey afc
331



grey afc
126

265611 MX PROSPECT/
FURY ANTI-STICK DL
WKS LENS



clear anti-stick works
332

PRIMAL / HUSTLE / TYRANT / SPLIT

SINGLE LENS

218814 MX PRIMAL/
HUSTLE/TYRANT/SPLIT
SINGLE WORKS LENS



clear afc works
102



electric blue chrome afc
works
282



orange chrome afc works
283



green chrome afc works
284



purple chrome afc works
285



yellow chrome afc works
301



silver chrome afc works
321



light sensitive grey afc
works
328



dark grey afc works
346

285678 MX PRIMAL/
HUSTLE/SPLIT/TYRANT
SINGLE LENS



clear afc
041



dark grey afc
346

PRIMAL / HUSTLE / TYRANT / SPLIT

DOUBLE LENS

218816 MX PRIMAL
HUSTLE/TYRANT/
SPLIT DL WORKS LENS



clear afc works
102

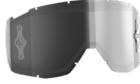

grey afc works
330

218818 MX PRIMAL/
HUSTLE/TYRANT/
SPLIT DL ACS LENS



clear afc
041



grey afc
126



light sensitive grey afc
331

SINGLE LENS

205187 MX
RECOILXI/80'S
SINGLE WORKS LENS



clear afc works
102



electric blue chrome afc
works
282



orange chrome afc works
283



yellow chrome afc works
301



silver chrome afc works
321



dark grey afc works
345

248777 MX BUZZ
SINGLE WORKS LENS



clear afc works
102



electric blue chrome afc
works
282



orange chrome afc works
283



purple chrome afc works
285



yellow chrome afc works
301



silver chrome afc works
321



gold chrome afc works
323



dark grey afc works
345

265520 MX BUZZ
SINGLE LENS



clear afc
041

242592 MX 89SI
SINGLE WORKS LENS



clear afc works
102

205192 MX 89SI
SINGLE LENS



clear afc
041

414514 89X
SINGLE LENS



clear afc
041

414514 89X / 89X ERA
SINGLE LENS

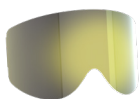

yellow chrome afc
364



orange chrome afc
365



silver chrome afc
363

DOUBLE LENS

207413 MX
RECOILXI/80'S DL
WORKS LENS



clear afc works
102



grey afc works
330

224007 MX
RECOILXI/80'S DL
ACS LENS



clear afc
041



grey afc
126

AMP

THE MOST INNOVATIVE LENS TECHNOLOGY SCOTT HAS EVER DEVELOPED

SCOTT's Off-Road injected molded AMP Lens Technology utilizes a unique light transmission curve to optimize the transmission of key light waves that are most important to the human eye, so you can see more in every condition.



WHAT IS CONTRAST?

The SCOTT AMP Technology tint is designed to let through some specific colors to your eye while filtering out others, in order to create a high contrast within the terrain you are looking at.

HOW DOES THE EYE PERCEIVE CONTRAST?

Through years of research we have learnt that our eyes are better at perceiving certain wavelengths than others. The eye can be thought of as the lens of a camera. There are parts and mechanisms inside the eye that control the vital role in our ability to see things in focus, color, darkness and brightness. By controlling what is let through the AMP lens, we can control how the external environment is perceived.

SCOTT AMP TECHNOLOGY IS AVAILABLE IN VARIOUS OFF-ROAD LENS OPTIONS

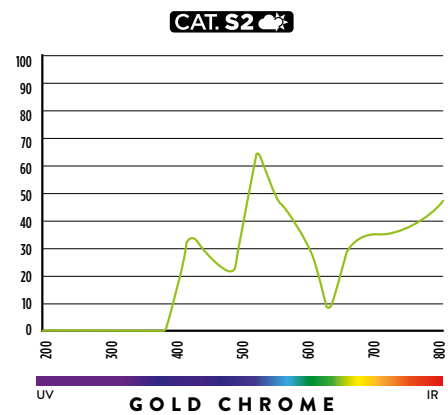
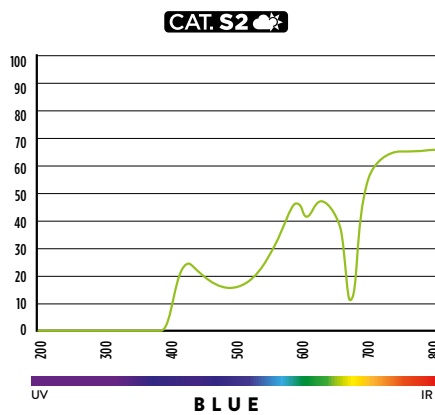
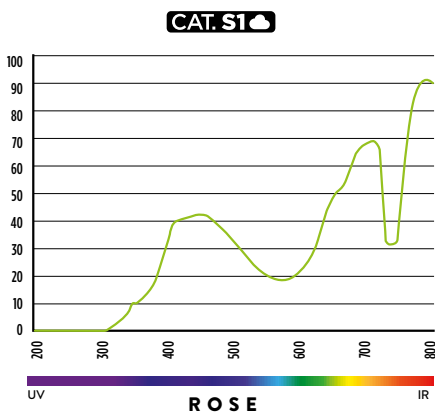

CONTRAST AMPLIFIED

SCOTT sets the industry standard for contrast enhancing optics with its patented AMP lens technology. The secret to AMP technology is its ability to add contrast while increasing clarity and definition in all racing conditions.

MAIN BENEFITS

- Allows you to see contours, ruts and transitions in the dirt in ultra-high-definition
- Works for both motocross and enduro
- Builds speed and confidence through improved visual clarity

▶ SCOTT PROSPECT AMP



AMPLIFY
YOUR
VISION

NO SHORTCUTS

AMP

SCOTT PROSPECT AMP GOGGLES TECHNOLOGY LINE UP 2024

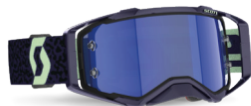

SCOTT LIGHT SENSITIVE LENSES

ONE LENS FOR EVERY LIGHT CONDITION

SCOTT's Light Sensitive lenses engage photo-chromic technology and adapt automatically to sunlight intensity to give you ultimate vision on the track regardless of the light conditions. These lenses automatically react to light changes and within seconds the lens will either darken when the brightness gets stronger or lighten when the sunlight gets weaker. This means going from bright sun into sudden shade has never been easier.



PROSPECT LIGHT SENSITIVE



SINGLE LENS : S0-2 / 28-86%
DOUBLE LENS : S1-2 / 26-76%

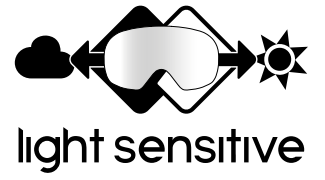

FURY LIGHT SENSITIVE



SINGLE LENS : S0-2 / 28-86%
DOUBLE LENS : S1-2 / 26-76%

SCOTT WORKS LENSES

SCOTT'S INNOVATIVE WORKS LENSES SET OUR GOGGLES APART FROM THE REST.

Featuring SCOTT's historic technology, the WORKS lens enables the rider to use the same lens for both tear-offs and roll-offs. With these do-it-all lenses, you can be fully prepared for whatever the weather might throw at you. Thanks to the factory-installed WORKS pins, scott roll-off systems or tear-offs can be easily and quickly mounted and removed depending on the race profile and track conditions.

4-PIN WORKS LENSES

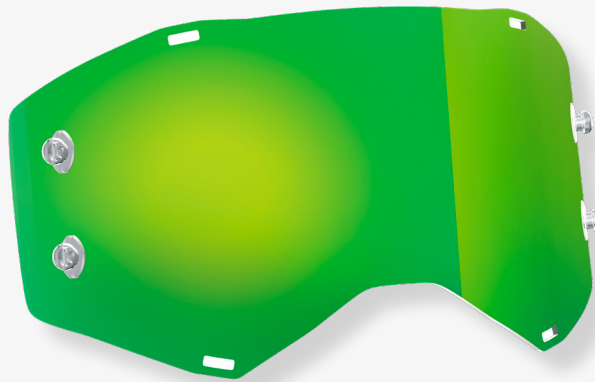

For the larger lens on the SCOTT Prospect and Fury goggles, the 4 pins provide more stability for the tear-offs and the WFS50. With this system the accessories will always remain tight to the lens and provide the rider with a better vision.

PROSPECT

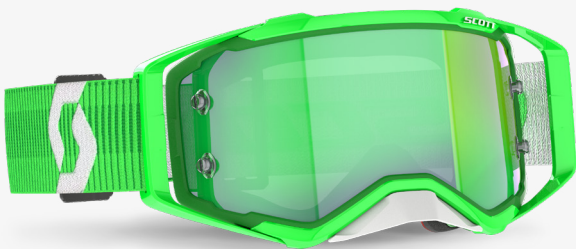

FURY.

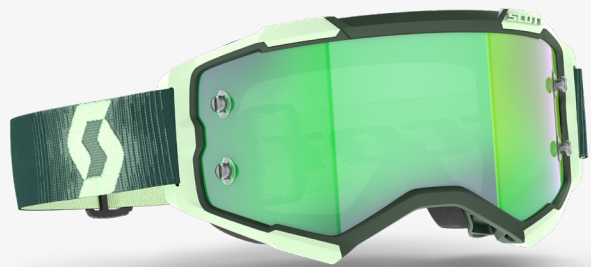

Suggested accessories



WORKS TEAR-OFF FITS PROSPECT/FURY PAK-20
248779



WFS 50 KIT W/ANTI-STICK GRID PROSPECT/FURY
248782



WFS ANTI-STICK GRID PROSPECT/FURY PAK-3
248790

SCOTT WORKS lens features



ANTIFOG
COATING



IMPACT
RESISTANCE



CHROME
COATING



UV
PROTECTION

2-PIN WORKS LENSES



Our Primal, Split and Buzz goggles can all be used with a classic 2 pin WORKS lens. The tried and tested 2 pin system allows you to easily mount both SCOTT tear-off's and the WFS kit securely to your lens for ultimate vision in challenging conditions.

PRIMAL



SPLIT 



Suggested accessories



WORKS TEAR-OFF FITS PRIMAL/SPLIT PAK-20
219690

WORKS TEAR-OFF BUZZ MX PAK-20
248781



WFS KIT W/ANTI-STICK GRID PRIMAL
248783

WFS KIT W/ANTI-STICK GRID BUZZ MX
248785



WFS ANTI-STICK GRID PRIMAL PAK-3
248791

WFS ANTI-STICK GRID BUZZ MX PAK-3
248793

FRAME & FOAM TECHNOLOGIES



Foam Technologies



NO SWEAT FACE FOAM

SCOTT's unique NoSweat Face Foam consists of a microfiber layer that is extremely water absorbent. It soaks up moisture fast and avoids sweat getting into your eyes or inside the goggle.



3 LAYER FACE FOAM

SCOTT's three-layer, open-celled face foam with fleece has excellent moisture-absorbing properties, and offers increased levels of comfort and an improved fit thanks to the extra layer of protective foam.



2 LAYER FACE FOAM

SCOTT's two-layer, open-celled face foam with fleece has excellent moisture-absorbing and thermal properties, ensuring that you stay warm, dry, and comfortable all day.



1 LAYER FACE FOAM

Thanks to the large, soft, single density face foam, a precise fit around facial features is provided while sealing out the elements.



DUSTCATCHER VENT FOAM

Dustcatcher vent foam is a purpose-engineered vent foam that has finer holes than standard to stop dust getting through the foam and into your goggles and eyes. Essential for any form of desert, beach or sand racing.

Frame Technologies



SILICONE STRAP

Adhered silicone strips on the inside of the goggle strap ensures the goggles stay in place on your helmet.



EXTRA WIDE NO-SLIP SILICONE STRAP

Our 50mm straps provide superior stability and comfort under any conditions as well as ultimate style.



LENS LOCK

The SCOTT Lens Lock System has been designed to guarantee the safest lens retention on the market. To avoid the lens coming out, this innovative Lens Lock System features four locking pins that go through the lens instead of grabbing it from the top.



ARTICULATING OUTRIGGERS

The Prospect has two pivoting outriggers that adapt to any helmet shape and size. The resulting pressure created by the goggle on the rider's face provides a complete and consistent seal.



RAM AIR

RAM (Revolutionary Air Management) System increases the airflow inside the goggle frame to avoid moisture on the lens.



OTG

OTG goggles offer protection from the elements and an optimized fit for people requiring prescription glasses, thanks to a specific and adapted construction.

LENS TECHNOLOGIES

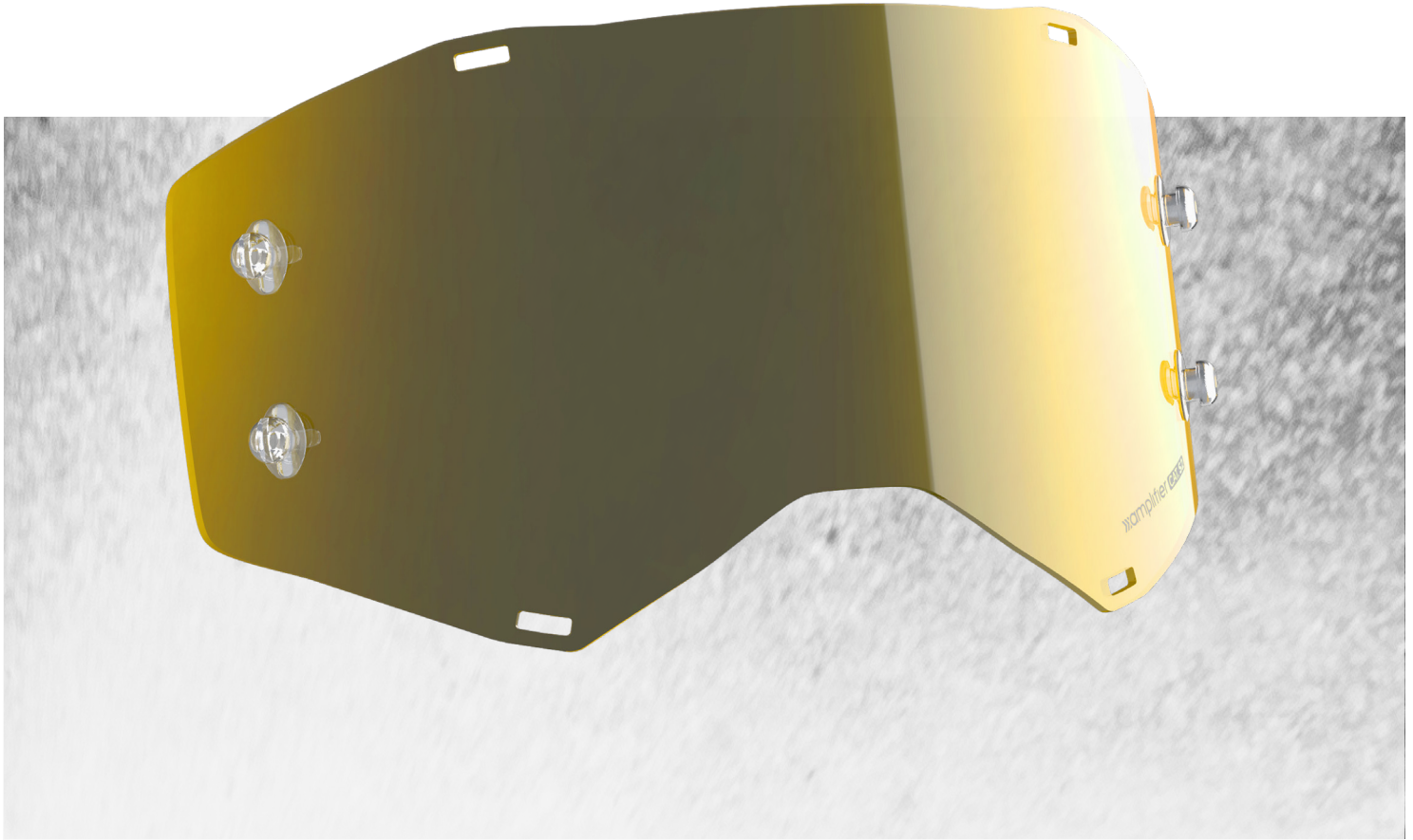

Lens Technologies



AMP

AMP is a technology to optimize visual contrast and clarity. The unique aspect of AMP is the shape of the visible light transmission curve, optimizing three specific wave lengths which are the most important for the human eye to enhance contrast and clarity.



light sensitive

LIGHT SENSITIVE

SCOTT Light Sensitive lenses engage photochromic technology and adapt automatically to sunlight intensity. Light Sensitive lenses react to light changes and within seconds the lens will darken if the sunlight gets stronger or lighten if the sunlight gets weaker.



ANTISTICK GRID WITH MUDFLAP

The anti-stick grid with an integrated mudflap provides a clear view throughout the entire ride. The mudflap is made out of a transparent material that offers a larger field of vision in dusty or less extreme conditions.



ANTISTICK DOTS

To ensure the smoothest film transfer possible, anti-stick dots on the lens provide pro-level performance when you need it most.



ACS

ACS ventilation incorporates lens air intake vents on the goggle lens and frame air outtake vents on the bottom of the goggle. The result is a sophisticated ventilation system that helps prevent condensation and fogging.



NOFOG

SCOTT lenses undergo a permanent NoFog™ treatment process to prevent condensation and fogging.



IMPACT RESISTANCE

In order to ensure that riders are safe from the impact of pebbles and flying debris, all SCOTT lenses not only meet, but exceed the required impact resistance standards required for MX lenses.



CHROME COATING

SCOTT chrome coating offers unmatched style for your goggles while controlling light transmittance.



UV PROTECTION

100% UV Protection All SCOTT lenses are optically engineered to screen out 100% of harmful UVA/UVB rays.

SCOTT WFS50 ROLL-OFF SYSTEM

DEFEND YOUR VISION

The SCOTT 50mm Works Film System (WFS50) is the ultimate solution to keeping your vision clear in muddy conditions. A larger than average film, easy to install canisters and intelligent design makes the highly reliable WFS50 roll-off system the no. 1 choice of pro and amateur riders alike.

INTEGRATED CANISTER DESIGN
fits perfectly with prospect outriggers

LARGE 50 MM FILM
Increased visibility

ULTRA-DURABLE HOUSING
Stops the film from unraveling mid-race



CLICK ON CANISTERS
Quick and easy to install

ANTISTICK GRID AND TRANSPARENT MUDFLAP
Increased performance & protection

PREMIUM PULL MECHANISM
Smooth & reliable action

Suggested accessories



WFS50 ROLL-OFF KIT PROSPECT/FURY WHITE
285679



WFS50 ROLL-OFF REFILLS PROSPECT/FURY (12-PACK)
248787



WFS ANTI-STICK GRID PROSPECT/FURY (3-PACK)
248790

▶ PROSPECT / FURY WFS



DEFEND YOUR VISION

NO SHORTCUTS



PROSPECT **FURY.**



SCOTT WFS GOGGLES

SCOTT PROSPECT / FURY WFS LINE UP 2024



MOTO LENS GUIDE

With a whole host of different lens options available in our range, this lens guide is designed to help make sure your vision is always the best it can be, by understanding which lenses work best in different light conditions.



CAT.S1 / CAT.S2: OPTIMIZING CONTRAST AND CLARITY

SINGLE LENS: CAT.S1 | CAT.S2



rose afc works
354
CAT.S1
VLT 51.5%

blue afc works
356
CAT.S2
VLT 31%

gold chrome afc works
323
CAT.S2
VLT 25%

S0-2 / S1-2: ONE LENS FOR EVERY LIGHT CONDITION

VISIBLE LIGHT TRANSMISSION
SINGLE LENS: S0-2 / 28-86% | DOUBLE LENS: S1-2 / 26-76%

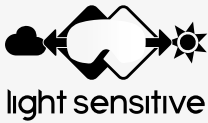

light sensitive grey
328
VLT 28-86%
single lens

light sensitive grey
328
VLT 26-76%
double lens

S0: DARK / OVERCAST

VISIBLE LIGHT TRANSMISSION - 80%-100%



clear afc works
102
VLT 87%

S1: MIXED / WHITE CLOUD

VISIBLE LIGHT TRANSMISSION - 43%-80%



pink chrome afc works
344
VLT 47%

orange chrome afc works
283
VLT 48%

electric blue chrome afc works
282
VLT 52%

grey afc works
330
VLT 54%

S2: BRIGHT SUNSHINE

VISIBLE LIGHT TRANSMISSION - 18%-43%



dark grey afc works
345
VLT 26%

purple chrome afc works
285
VLT 28%

yellow chrome afc works
301
VLT 35%

silver chrome afc works
321
VLT 39%

green chrome afc works
284
VLT 40%



AIROH

MONSTER
ENERGY



MONSTER